

# Approval Sheet

## (產品承認書)

產品名稱 (Product): BT 4.2 Module (nRF52832)

產品型號 (Model No.): MDBT42Q Series

MDBT42Q-P Series

*Advantage of MDBT42Q & MDBT42Q-P series:*

- 1. Long working distance:  
**MDBT42Q:** over 80 meters in open space.  
**MDBT42Q-P:** up to 60 meters in open space.*
- 2. Granted main regional certification such as FCC (USA),  
IC (Canada), TELEC (Japan), SRRC (China), NCC (Taiwan).*
- 3. RoHS and REACH compliant.*

# Index

<b>List of Raytac's BLE Model No.</b> .....	<b>3</b>
<b>1. Overall Introduction</b> .....	<b>4</b>
1.1. Application .....	4
1.2. Features .....	5
1.3. Profile & Service Information .....	6
<b>2. Product Dimension</b> .....	<b>7</b>
2.1. <b>MDBT42Q</b> Series .....	7
2.2. <b>MDBT42Q-P</b> Series.....	12
2.3. RF Layout Suggestion (aka Keep-Out Area) .....	17
2.4. Pin Assignment.....	18
2.5. GPIO Located Near the Radio .....	20
<b>3. Main Chip Solution</b> .....	<b>20</b>
<b>4. Shipment Packaging Information</b> .....	<b>21</b>
4.1. Marking on Metal Shielding .....	22
<b>5. Specification</b> .....	<b>23</b>
5.1. Absolute Maximum Ratings .....	23
5.2. Operation Conditions .....	23
5.3. Electrical Specifications .....	24
<b>6. Block Diagram</b> .....	<b>29</b>
<b>7. Antenna</b> .....	<b>30</b>
7.1. <b>MDBT42Q</b> Series .....	30
7.2. <b>MDBT42Q-P</b> Series.....	31
<b>8. Reference Circuit</b> .....	<b>32</b>
<b>9. Certification</b> .....	<b>33</b>
9.1. FCC Certificate (USA) .....	33
9.2. TELEC Certificate (Japan).....	34
9.3. NCC Certificate (Taiwan) .....	35
9.4. IC Certificate (Canada) .....	37
9.5. SRRC Certificate (China).....	38
9.6. RoHS & REACH Report .....	39
9.7. End-Product Label .....	40
<b>Release Note</b> .....	<b>42</b>

# List of Raytac's BLE Model No.

## MDBT40 & MDBT40-P Series

Series	Nordic Solution	Raytac No.	IC Version	Antenna	RAM	Flash Memory
MDBT40	nRF51822	MDBT40-128V3	3	Chip Antenna	16 kb	128 K
		MDBT40-256V3				256 K
		MDBT40-256RV3			32 kb	256 K
MDBT40-P	nRF51822	MDBT40-P128V3	3	PCB Antenna	16 kb	128 K
		MDBT40-P256V3				256 K
		MDBT40-P256RV3			32 kb	256 K
MDBT40 - ANT	nRF51422	MDBT40-ANT-256V3	3	Chip Antenna	16 kb	256 K
		MDBT40-ANT-256RV3			32 kb	
MDBT40 - ANT-P	nRF51422	MDBT40-ANT-P256V3	3	PCB Antenna	16 kb	256 K
		MDBT40-ANT-P256RV3			32 kb	
MDBT40 Nano	nRF51822	MDBT40-n256V3	3	N/A	16 kb	256 K
MDBT40 - ANT-Nano	nRF51422	MDBT40-ANT-n256V3	3	N/A	16 kb	256 K

## MDBT42Q & MDBT42Q-P Series

Series	Nordic Solution	Raytac No.	IC Version	Antenna	RAM	Flash Memory
MDBT42Q	nRF52832	MDBT42Q-512K	1	Chip Antenna	64 kb	512 K
MDBT42Q-P	nRF52832	MDBT42Q-P512K	1	PCB Antenna	64 kb	512 K

# 1. Overall Introduction

Raytac's MDBT42Q & MDBT42Q-P is a BT 4.0, BT 4.1 and BT 4.2 stack (Bluetooth low energy or BLE) module designed based on **Nordic nRF52832 SoC solution**, which incorporates: **GPIO, SPI, UART, I2C, I2S, PWM** and **ADC** interfaces for connecting peripherals and sensors.

Features of the module:

1. Dual Transmission mode of BLE & 2.4Ghz RF upon customer preference.
2. Compact size with **(L) 16 x (W) 10 x (H) 2.2 mm**.
3. Low power requirements, ultra-low peak, average and idle mode power consumption.
4. Be compatible with a large installed base of mobile phones, tablets and computers.
5. Fully coverage of BLE software stack. See 1.3 Profile & Service Information.
6. BLE & RF transmission switching helps products fit all operation system and most hardware.

## 1.1. Application

- IoT
  - Home automation
  - Sensor networks
  - Building automation
- Personal Area Networks
  - Health / fitness sensor and monitor device
  - Medical devices
  - Key-fobs and wrist watches
- Interactive entertainment devices
  - Remote control
  - Gaming controller
- Beacons
- A4WP wireless chargers and devices
- Remote control toys
- Computer peripherals and I/O devices
  - Mouse
  - Keyboard
  - Multi-touch trackpad

## 1.2. Features

- Multi-protocol 2.4GHz radio
- 32-bit ARM Cortex – M4F processor
- 512KB flash programmed memory and 64KB RAM
- Software stacks available as downloads
- Application development independent from protocol stack
- On-air compatible with nRF51, nRF24AP and nRF24L series
- Programmable output power from +4dBm to -20dBm
- RSSI
- RAM mapped FIFOs using EasyDMA
- Dynamic on-air payload length up to 256 bytes
- Flexible and configurable 32 pin GPIO
- Programmable peripheral interface - PPI
- Simple ON / OFF global power mode
- Full set of digital interface all with Easy DMA including:
  - 3 x Hardware SPI master ; 3 x Hardware SPI slave
  - 2 x two-wire master ; 2 x two-wire slave
  - 1 x UART (CTS / RTS)
  - PDM for digital microphone
  - I2S for audio
- Quadrature demodulator
- 12-bit / 200KSPS ADC
- 128-bit AES ECB / CCM / AAR co-processor
- Low cost external crystal 32MHz  $\pm$  40ppm for Bluetooth ;  $\pm$  50ppm for ANT Plus
- Low power 32MHz crystal and RC oscillators
- Wide supply voltage range 1.7V to 3.6V
- On-chip DC/DC buck converter
- Individual power management for all peripherals
- Timer counter
  - 5 x 32-bit
  - 3 x 24-bit RTC
- NFC-A tag interface for OOB pairing

### 1.3. Profile & Service Information

Profile & Service are supported by MDBT42Q & MDBT42Q-P as below:

<b>Profile Description</b>	<b>Service Description</b>
Alert Notification Profile	Alert Notification Service
Blood Pressure Profile	Blood Pressure Service
	Device Information Service
Cycling Speed & Cadence Profile	Cycling Speed & Cadence Service
	Device Information Service
Glucose Profile	Glucose Service
	Device Information Service
Health Thermometer Profile	Health Thermometer Service
	Device Information Service
Heart Rate Profile	Heart Rate Service
	Device Information Service
HID over GATT Profile	HID Service
	Battery Service
Proximity Profile	Link Loss Service
	Immediate Alert Service
	TX Power Service
Running Speed & Cadence Profile	Running Speed & Cadence Service
	Device Information Service

## 2. Product Dimension

### 2.1. MDBT42Q Series

- PCB Dimensions, Pin Indication and Layout Guide

**PCB SIZE: (L) 16 x (W) 10 x (H) 2.2 mm**

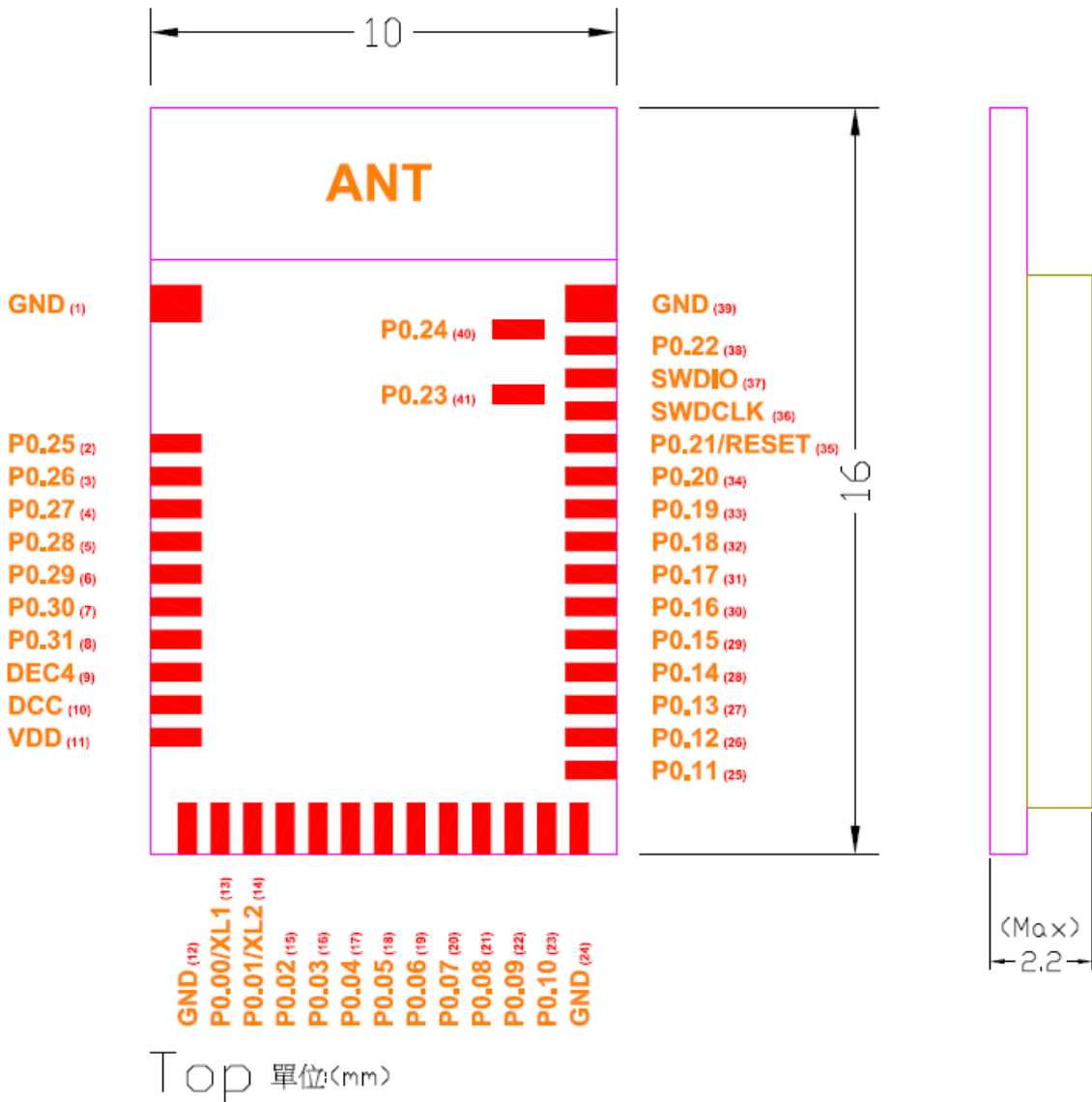

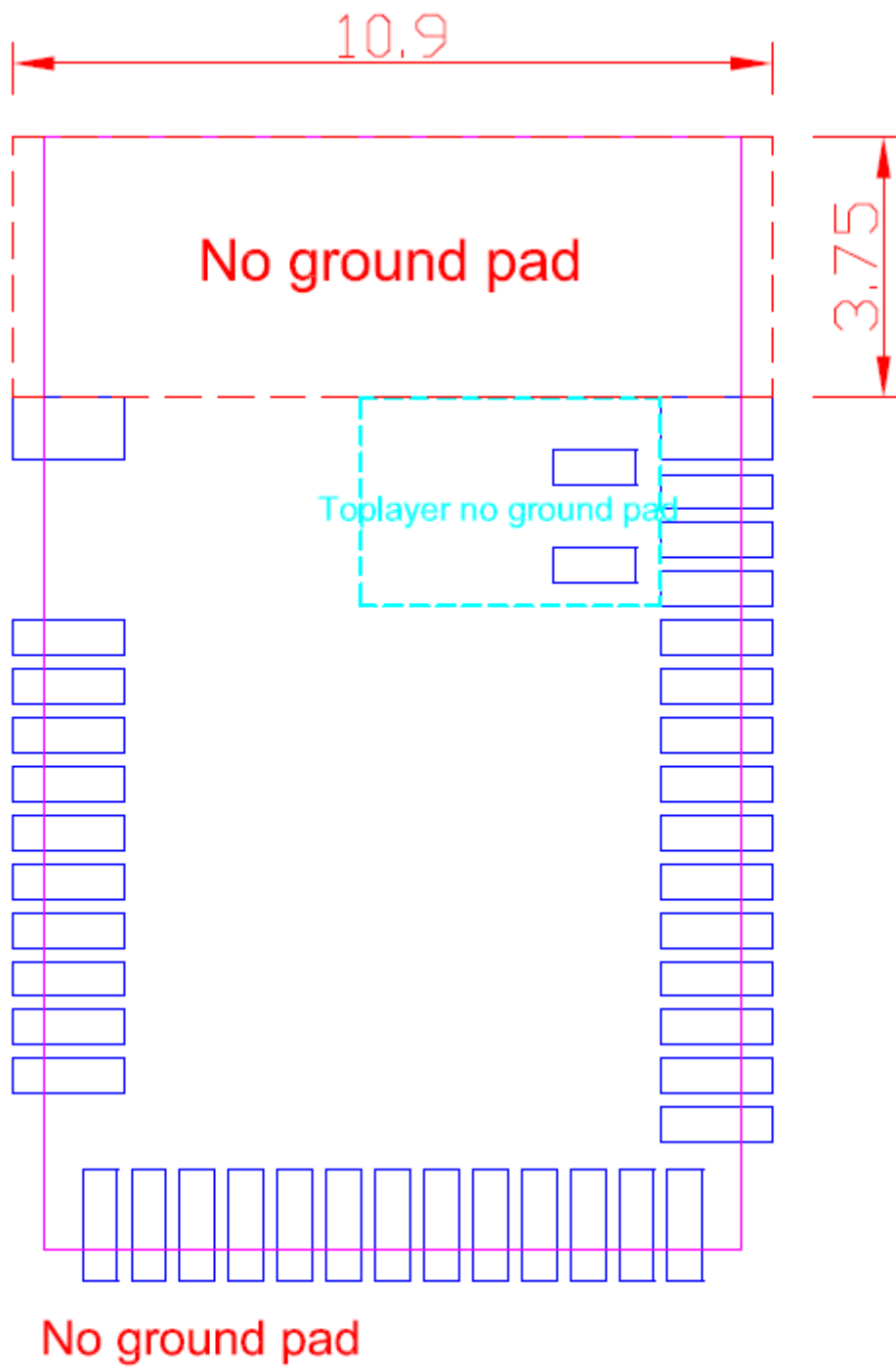



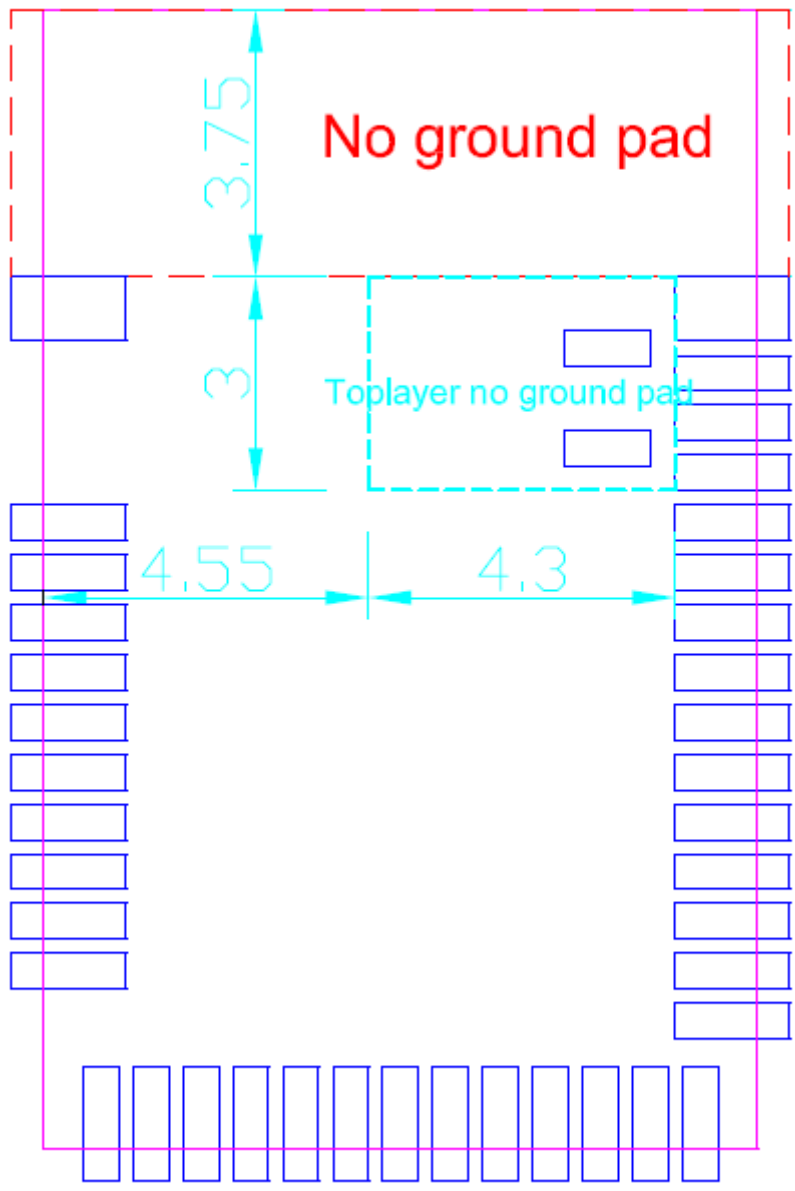

Toplayer no ground pad

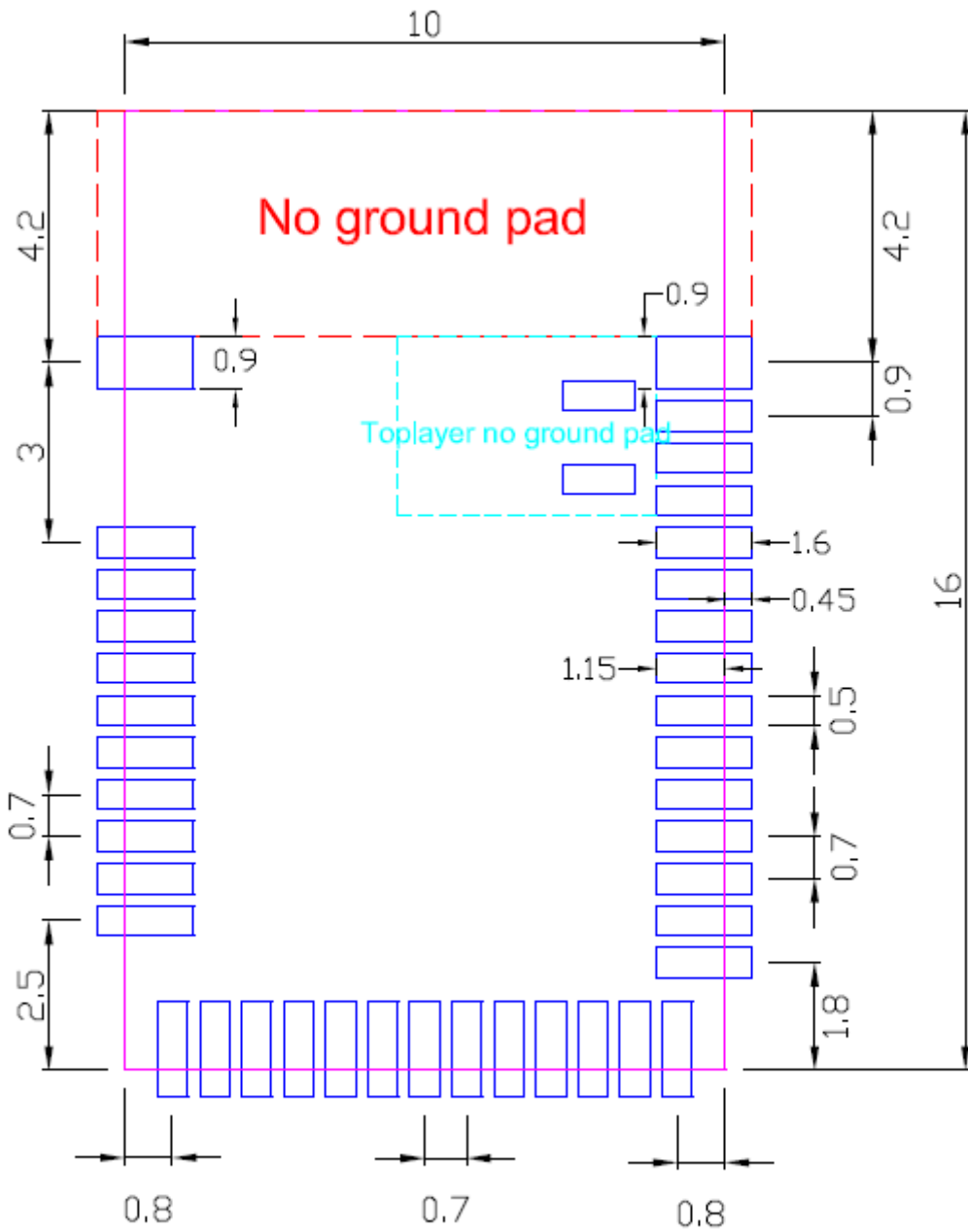

Top View (單位: mm)  
recommended solder pad layout

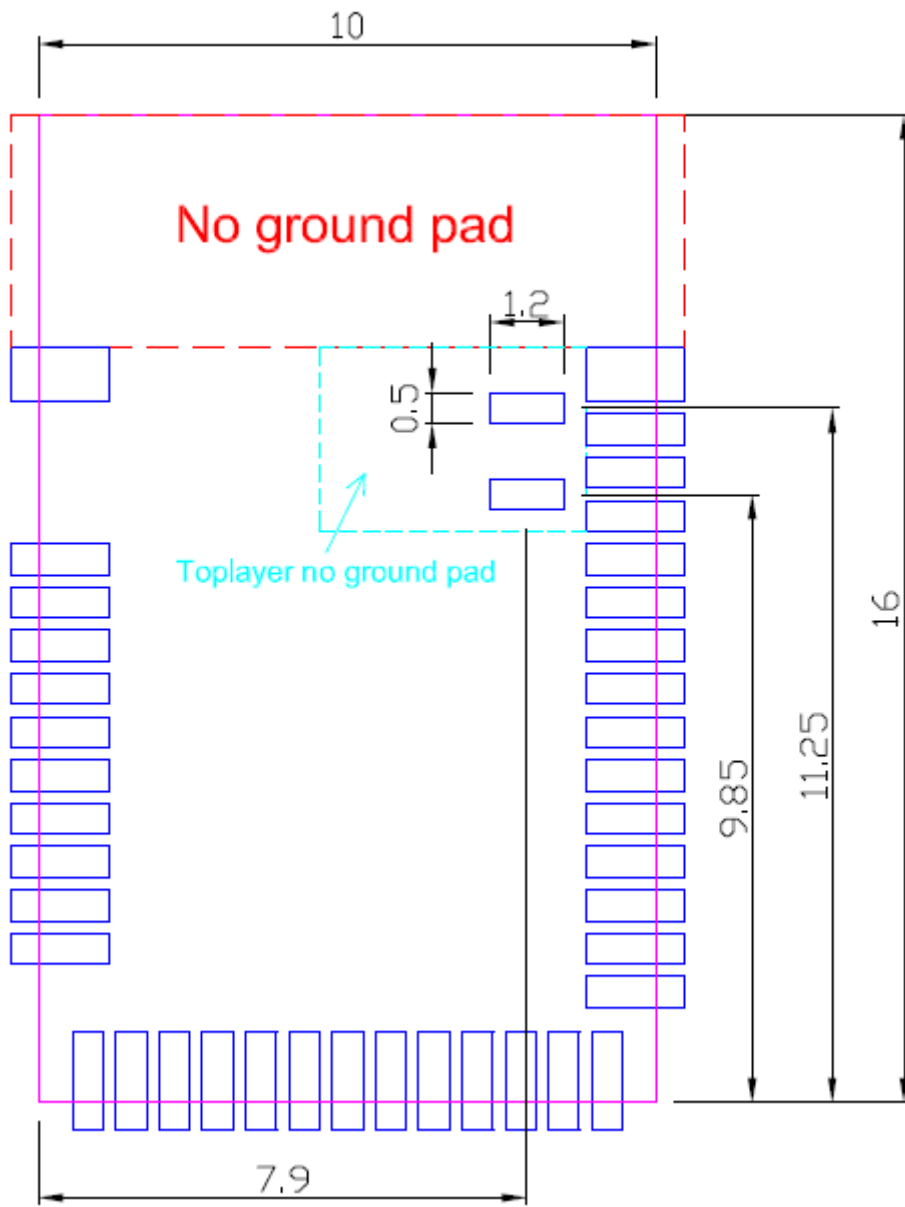

## 2.2. MDBT42Q-P Series

- PCB Dimensions, Pin Indication and Layout Guide

**PCB SIZE: (L) 16 x (W) 10 x (H) 2.2 mm**

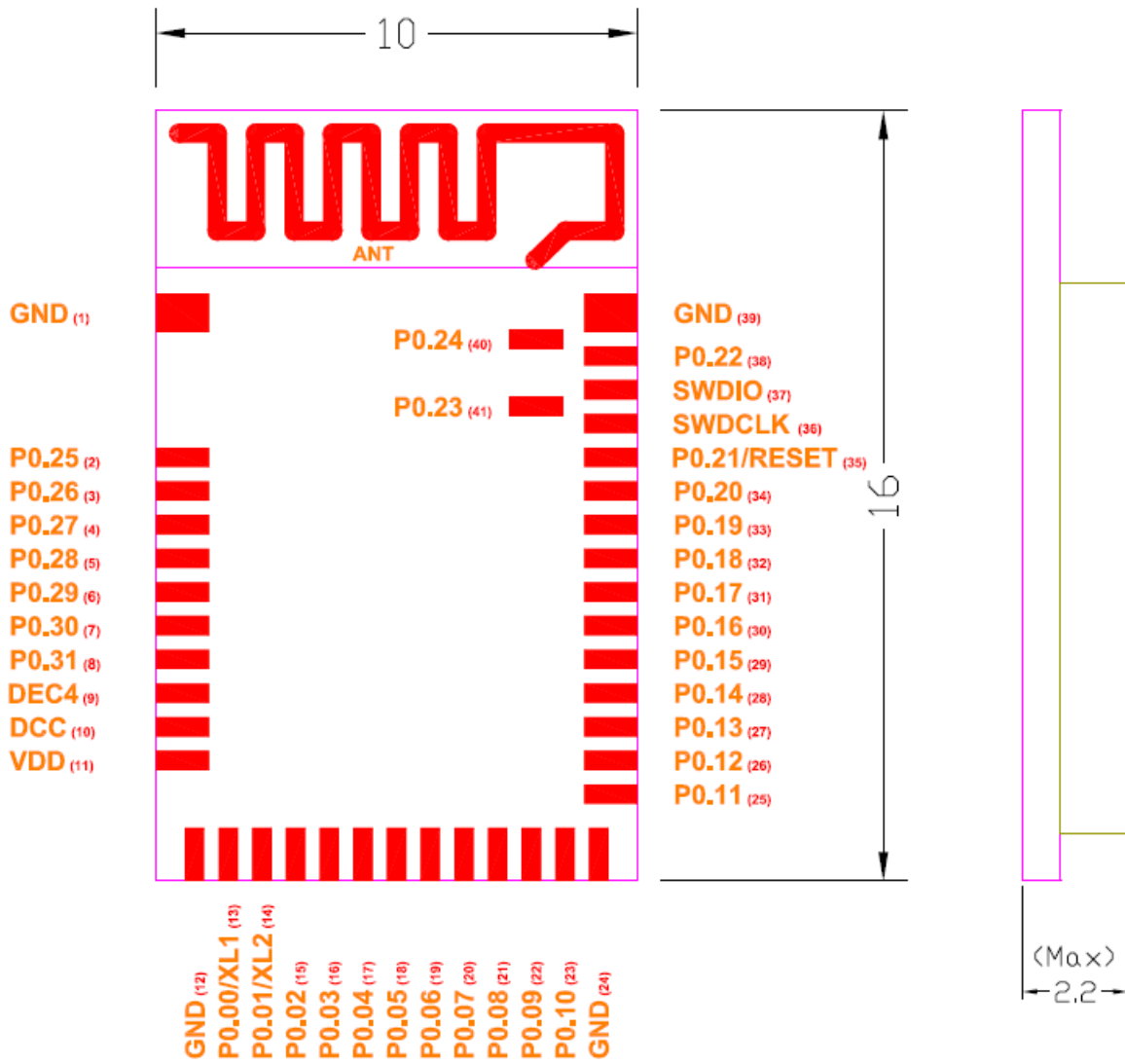

Top 單位(mm)

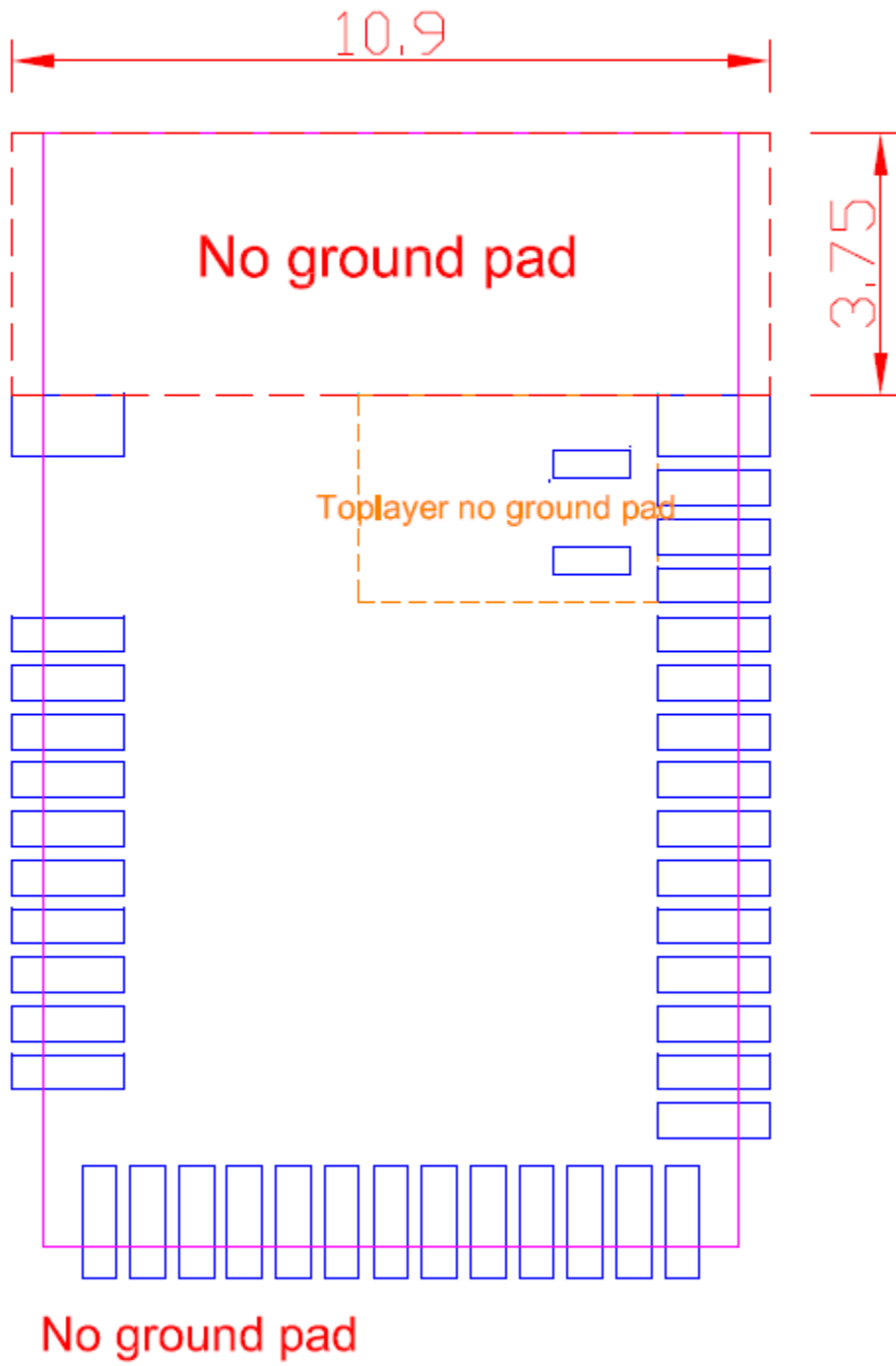

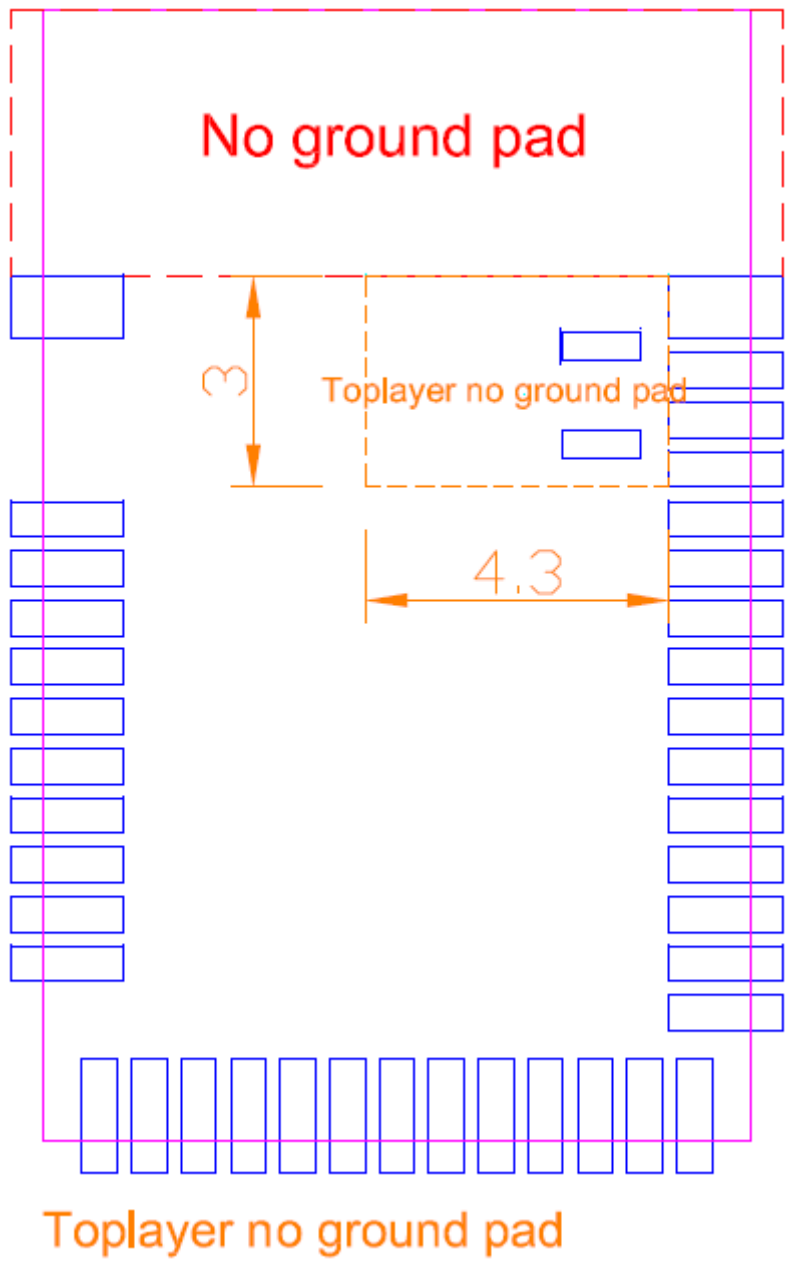

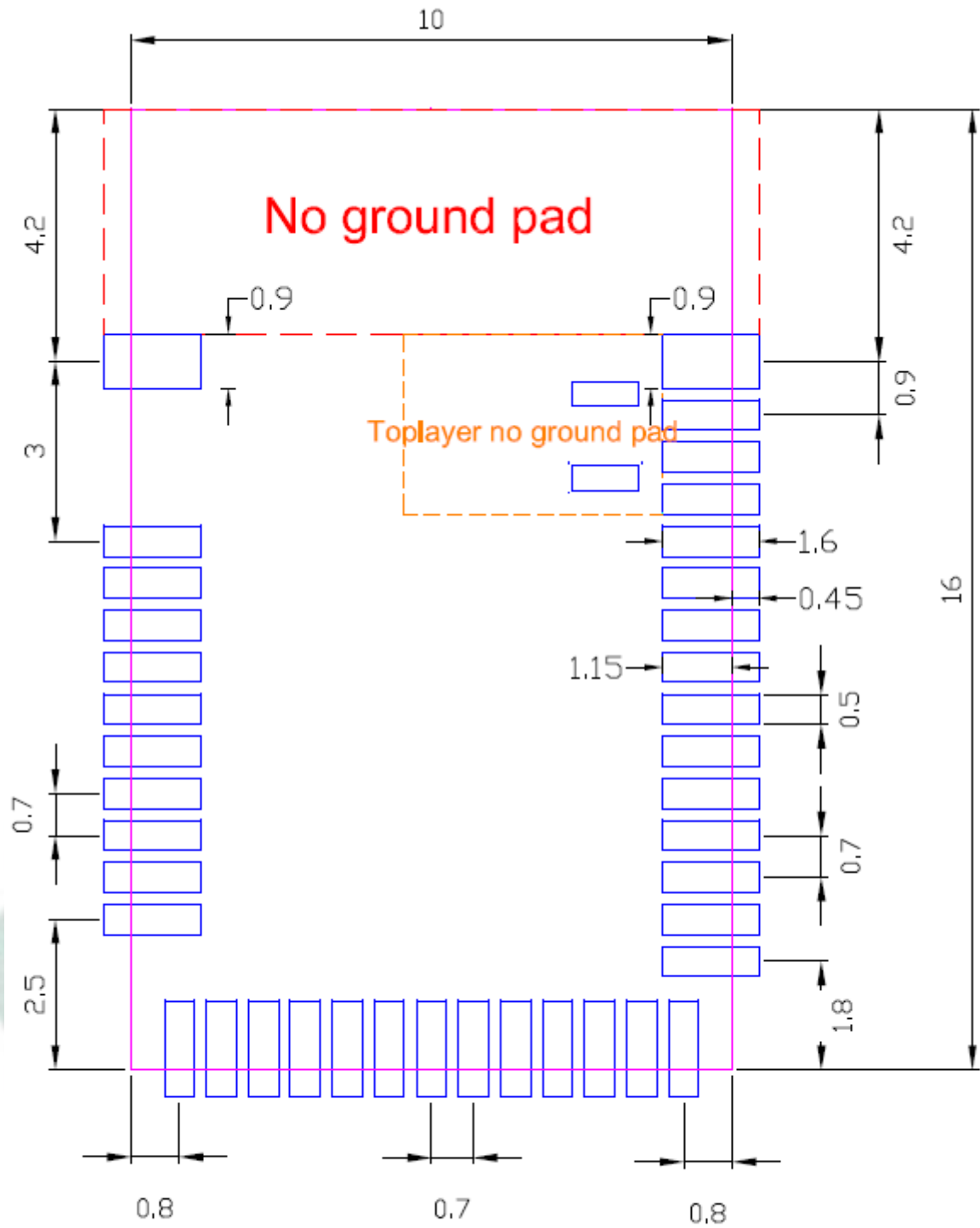

Top View (單位: mm)  
recommended solder pad layout

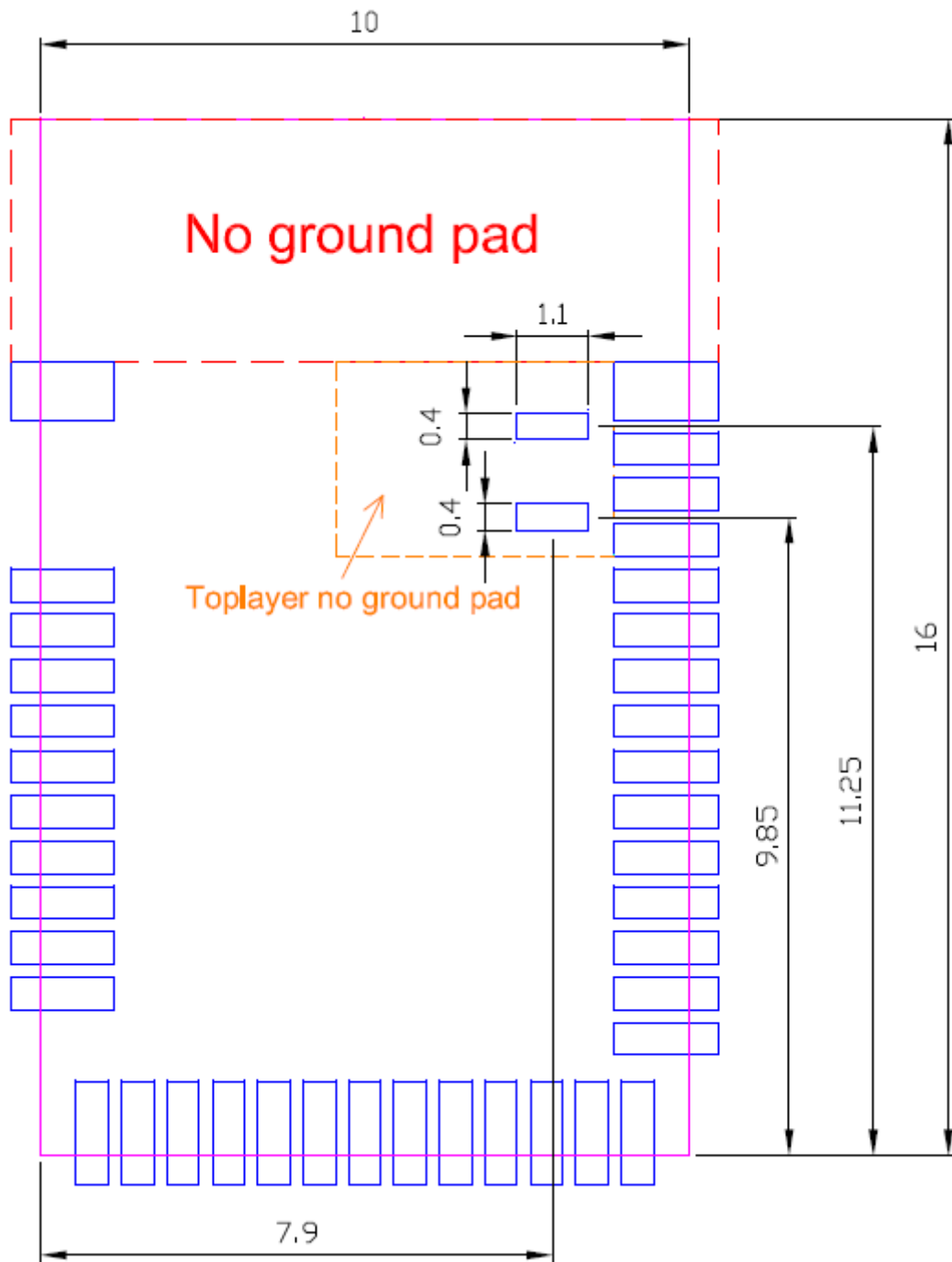



### 2.3. RF Layout Suggestion (aka Keep-Out Area)

Layout is suggested following below instruction to have better wireless performance. When design is not allowed to leave such space, please make sure to keep the “No-Ground-Pad” as wider as it can.

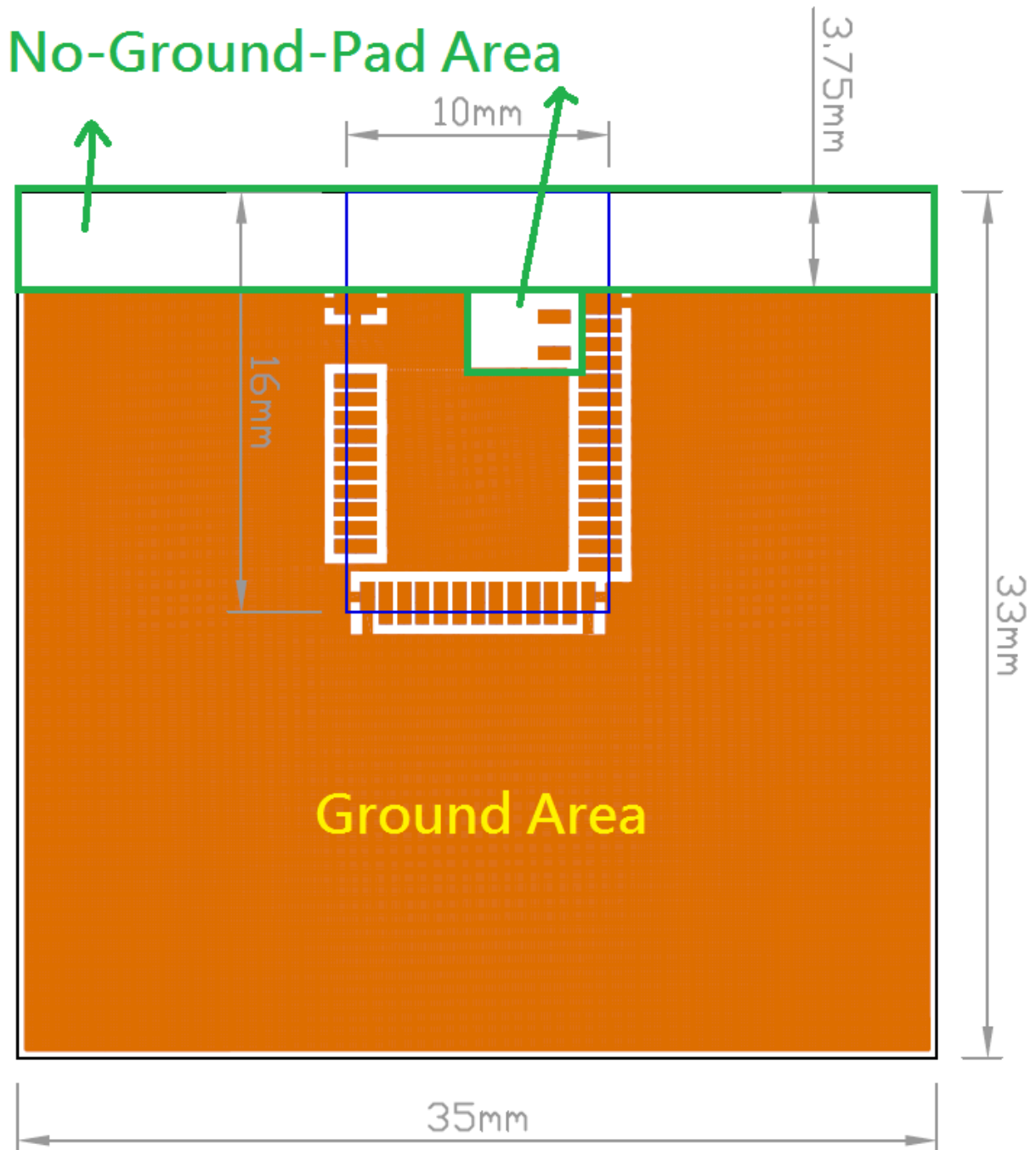

## 2.4. Pin Assignment

Pin No.	Name	Pin function	Description
(1)	<b>GND</b>	Ground	The pad must be connected to a solid ground plane
(2)	<b>P0.25</b>	Digital I/O	General-purpose digital I/O
(3)	<b>P0.26</b>	Digital I/O	General-purpose digital I/O
(4)	<b>P0.27</b>	Digital I/O	General-purpose digital I/O
(5)	<b>P0.28</b>	Digital I/O	General-purpose digital I/O
	<b>AIN4</b>	Analog input	SAADC/COMP/LPCOMP input
(6)	<b>P0.29</b>	Digital I/O	General-purpose digital I/O
	<b>AIN5</b>	Analog input	SAADC/COMP/LPCOMP input
(7)	<b>P0.30</b>	Digital I/O	General-purpose digital I/O
	<b>AIN6</b>	Analog input	SAADC/COMP/LPCOMP input
(8)	<b>P0.31</b>	Digital I/O	General-purpose digital I/O
	<b>AIN7</b>	Analog input	SAADC/COMP/LPCOMP input
(9)	<b>DEC4</b>	Power	1V3 regulator supply decoupling. Input from DC/DC converter. Output from 1V3 LDO .
(10)	<b>DCC</b>	Power	DC/DC converter output pin
(11)	<b>VDD</b>	Power	Power-supply pin
(12)	<b>GND</b>	Ground	The pad must be connected to a solid ground plane
(13)	<b>P0.00</b>	Digital I/O	General-purpose digital I/O
	<b>XL1</b>	Analog input	Connection to 32.768khz crystal (LFXO)
(14)	<b>P0.01</b>	Digital I/O	General-purpose digital I/O
	<b>XL2</b>	Analog input	Connection to 32.768khz crystal (LFXO)
(15)	<b>P0.02</b>	Digital I/O	General-purpose digital I/O
	<b>AIN0</b>	Analog input	SAADC/COMP/LPCOMP input
(16)	<b>P0.03</b>	Digital I/O	General-purpose digital I/O
	<b>AIN1</b>	Analog input	SAADC/COMP/LPCOMP input
(17)	<b>P0.04</b>	Digital I/O	General-purpose digital I/O
	<b>AIN2</b>	Analog input	SAADC/COMP/LPCOMP input
(18)	<b>P0.05</b>	Digital I/O	General-purpose digital I/O
	<b>AIN3</b>	Analog input	SAADC/COMP/LPCOMP input
(19)	<b>P0.06</b>	Digital I/O	General-purpose digital I/O
(20)	<b>P0.07</b>	Digital I/O	General-purpose digital I/O
(21)	<b>P0.08</b>	Digital I/O	General-purpose digital I/O

Pin No.	Name	Pin function	Description
(22)	P0.09	Digital I/O	General-purpose digital I/O
	NFC1	NFC input	NFC antenna connection
(23)	P0.10	Digital I/O	General-purpose digital I/O
	NFC2	NFC input	NFC antenna connection
(24)	GND	Ground	The pad must be connected to a solid ground plane
(25)	P0.11	Digital I/O	General-purpose digital I/O
(26)	P0.12	Digital I/O	General-purpose digital I/O
(27)	P0.13	Digital I/O	General-purpose digital I/O
(28)	P0.14	Digital I/O	General-purpose digital I/O
	TraceData(3)		Trace port output
(29)	P0.15	Digital I/O	General-purpose digital I/O
	TraceData(2)		Trace port output
(30)	P0.16	Digital I/O	General-purpose digital I/O
	TraceData(1)		Trace port output
(31)	P0.17	Digital I/O	General-purpose digital I/O
(32)	P0.18	Digital I/O	General-purpose digital I/O
	TraceData(0)		Trace port output
(33)	P0.19	Digital I/O	General-purpose digital I/O
(34)	P0.20	Digital I/O	General-purpose digital I/O
	TraceCLK		Trace port clock output
(35)	P0.21	Digital I/O	General-purpose digital I/O
	RESET		Configurable as system RESET pin
(36)	SWDCLK	Digital input	Serial Wire debug clock input for debug and programming
(37)	SWDIO	Digital I/O	Serial Wire debug I/O for debug and programming
(38)	P0.22	Digital I/O	General-purpose digital I/O
(39)	GND	Ground	The pad must be connected to a solid ground plane
(40)	P0.24	Digital I/O	General-purpose digital I/O
(41)	P0.23	Digital I/O	General-purpose digital I/O

## 2.5. GPIO Located Near the Radio

Below remarks are extracted from Nordic's nRF52832 Spec. Any updates shall refer to Nordic's official release as final reference.

### 20.2.1 GPIO located near the radio

Radio performance parameters, such as sensitivity, may be affected by high frequency digital I/O with large sink/source current close to the Radio power supply and antenna pins.

*Table 23: GPIO recommended usage* on page 109 identifies some GPIO that have recommended usage guidelines to maximize radio performance in an application.



### Table 23: GPIO recommended usage

Pin	GPIO	Recommended usage
27	P0.22	Low drive, low frequency I/O only.
28	P0.23	
29	P0.24	
37	P0.25	
38	P0.26	
39	P0.27	
40	P0.28	
41	P0.29	
42	P0.30	

## 3. Main Chip Solution

RF IC	Crystal Frequency
Nordic NRF52832	32MHZ



## 4. Shipment Packaging Information

Antenna	Model
Chip/Ceramic Antenna	MDBT42Q-512K
	
PCB/Printed Antenna	MDBT42Q-P512K
	

- Unit Weight of Module: MDBT42Q-512K: 0.64g/pc ; MDBT42Q-P512K: 0.62g/pc
- Packaging Type: Tray only
- Minimum Package Quantity (MPQ): 88 pcs per Tray
- Carton Contents: 1760 pcs per carton (20 Full Tray + 1 Empty Tray)
- Dimension of Carton: (L) 37 x (W) 21 x (H) 13 cm
- Gross Weight: approx. 2.80 kgs per full carton (contains 1760pcs)



## 4.1. Marking on Metal Shielding

Raytac Corporation  
FCC ID: SH6MDBT42Q  
IC: 8017A-MDBT42Q  
CMIIT ID: 2016DJ457  
 Model No.: MDBT42Q  
 201-160496



## 5. Specification

### 5.1. Absolute Maximum Ratings

Note	Min.	Max.	Unit
<b>Supply voltages</b>			
VDD	-0.3	+3.9	V
VSS		0	V
<b>I/O pin voltage</b>			
$V_{I/O}$ , VDD $\leq$ 3.6 V	-0.3	VDD + 0.3 V	V
$V_{I/O}$ , VDD $>$ 3.6 V	-0.3	3.9 V	V
<b>NFC antenna pin current</b>			
$I_{NFC1/2}$ Radio		80	mA
RF input level		10	dBm
<b>Environmental (QFN package)</b>			
Storage temperature	-40	+125	°C
MSL	Moisture Sensitivity Level	2	
ESD HBM	Human Body Model	4	kV
ESD CDM <sub>QF</sub>	Charged Device Model (QFN48, 6x6 mm package)	750	V
<b>Flash memory</b>			
Endurance	10 000		Write/erase cycles
Retention	10 years at 40°C		

### 5.2. Operation Conditions

Symbol	Parameter	Min.	Nom.	Max.	Units
VDD	Supply voltage, independent of DCDC enable	1.7	3.0	3.6	V
$t_{R\_VDD}$	Supply rise time (0 V to 1.7 V)			60	ms
TA	Operating temperature	-40	25	85	°C

**Important:** The on-chip power-on set circuitry may not function properly for rise times longer than the specified maximum.



## 5.3. Electrical Specifications

### 5.3.1. General Radio Characteristics

Symbol	Description	Min.	Typ.	Max.	Units
$f_{OP}$	Operating frequencies	2360		2500	MHz
$f_{PLL,PROG,RES}$	PLL programming resolution		2		kHz
$f_{PLL,CH,SP}$	PLL channel spacing		1		MHz
$f_{DELTA,1M}$	Frequency deviation @ 1 Msps		$\pm 170$		kHz
$f_{DELTA,BLE,1M}$	Frequency deviation @ BLE 1Msps		$\pm 250$		kHz
$f_{DELTA,2M}$	Frequency deviation @ 2 Msps		$\pm 320$		kHz
$f_{sk_{SPS}}$	On-the-air data rate	1		2	Msps

### 5.3.2. Radio Current Consumption (Transmitter)

Symbol	Description	Min.	Typ.	Max.	Units
$I_{TX,PLUS4dBm,DCDC}$	TX only run current (DCDC, 3V) $P_{RF} = +4$ dBm		7.5		mA
$I_{TX,PLUS4dBm}$	TX only run current $P_{RF} = +4$ dBm		16.6		mA
$I_{TX,0dBm,DCDC}$	TX only run current (DCDC, 3V) $P_{RF} = 0$ dBm		5.3		mA
$I_{TX,0dBm}$	TX only run current $P_{RF} = 0$ dBm		11.6		mA
$I_{TX,MINUS4dBm,DCDC}$	TX only run current DCDC, 3V $P_{RF} = -4$ dBm		4.2		mA
$I_{TX,MINUS4dBm}$	TX only run current $P_{RF} = -4$ dBm		9.3		mA
$I_{TX,MINUS8dBm,DCDC}$	TX only run current DCDC, 3V $P_{RF} = -8$ dBm		3.8		mA
$I_{TX,MINUS8dBm}$	TX only run current $P_{RF} = -8$ dBm		8.4		mA
$I_{TX,MINUS12dBm,DCDC}$	TX only run current DCDC, 3V $P_{RF} = -12$ dBm		3.5		mA
$I_{TX,MINUS12dBm}$	TX only run current $P_{RF} = -12$ dBm		7.7		mA
$I_{TX,MINUS16dBm,DCDC}$	TX only run current DCDC, 3V $P_{RF} = -16$ dBm		3.3		mA
$I_{TX,MINUS16dBm}$	TX only run current $P_{RF} = -16$ dBm		7.3		mA
$I_{TX,MINUS20dBm,DCDC}$	TX only run current DCDC, 3V $P_{RF} = -20$ dBm		3.2		mA
$I_{TX,MINUS20dBm}$	TX only run current $P_{RF} = -20$ dBm		7.0		mA
$I_{TX,MINUS40dBm,DCDC}$	TX only run current DCDC, 3V $P_{RF} = -40$ dBm		2.7		mA
Symbol	Description	Min.	Typ.	Max.	Units
$I_{TX,MINUS40dBm}$	TX only run current $P_{RF} = -40$ dBm		5.9		mA
$I_{START,TX,DCDC}$	TX start-up current DCDC, 3V, $P_{RF} = 4$ dBm		4.0		mA
$I_{START,TX}$	TX start-up current, $P_{RF} = 4$ dBm		8.8		mA



### 5.3.3. Radio Current Consumption (Receiver)

Symbol	Description	Min.	Typ.	Max.	Units
$I_{RX,1M,DCDC}$	RX only run current (DCDC, 3V) 1MSPS / 1MSPS BLE		5.4		mA
$I_{RX,1M}$	RX only run current 1MSPS / 1MSPS BLE		11.7		mA
$I_{RX,2M,DCDC}$	RX only run current (DCDC, 3V) 2MSPS		5.8		mA
$I_{RX,2M}$	RX only run current 2MSPS		12.9		mA
$I_{START,RX,1M,DCDC}$	RX start-up current (DCDC 3V) 1MSPS / 1MSPS BLE		3.5		mA
$I_{START,RX,1M}$	RX start-up current 1MSPS / 1MSPS BLE		7.5		mA

### 5.3.4. Transmitter Specification

Symbol	Description	Min.	Typ.	Max.	Units
$P_{RF}$	Maximum output power		4	6	dBm
$P_{RFC}$	RF power control range		24		dB
$P_{RFCR}$	RF power accuracy			±4	dB
$P_{RF1,1}$	1st Adjacent Channel Transmit Power 1 MHz (1 MspS)		-25		dBc
$P_{RF2,1}$	2nd Adjacent Channel Transmit Power 2 MHz (1 MspS)		-50		dBc
$P_{RF1,2}$	1st Adjacent Channel Transmit Power 2 MHz (2 MspS)		-25		dBc
$P_{RF2,2}$	2nd Adjacent Channel Transmit Power 4 MHz (2 MspS)		-50		dBc

### 5.3.5. Receiver Operation

Symbol	Description	Min.	Typ.	Max.	Units
$P_{RX,MAX}$	Maximum received signal strength at < 0.1% PER		0		dBm
$P_{SENS,IT,1M}$	Sensitivity, 1MSPS nRF mode <sup>15</sup>		-93		dBm
$P_{SENS,IT,SP,1M,BLE}$	Sensitivity, 1MSPS BLE ideal transmitter, <=37 bytes BER=1E-3 <sup>16</sup>		-96		dBm
$P_{SENS,IT,LP,1M,BLE}$	Sensitivity, 1MSPS BLE ideal transmitter >=128 bytes BER=1E-4 <sup>17</sup>		-95		dBm
$P_{SENS,IT,2M}$	Sensitivity, 2MSPS nRF mode <sup>18</sup>		-89		dBm

## 5.3.6. RX Selectivity

Symbol	Description	Min.	Typ.	Max.	Units
$C/I_{1M,co-channel}$	1 Msps mode, Co-Channel interference		9		dB
$C/I_{1M,-1MHz}$	1 Msps mode, Adjacent (-1 MHz) interference		-2		dB
$C/I_{1M,+1MHz}$	1 Msps mode, Adjacent (+1 MHz) interference		-10		dB
$C/I_{1M,-2MHz}$	1 Msps mode, Adjacent (-2 MHz) interference		-19		dB
$C/I_{1M,+2MHz}$	1 Msps mode, Adjacent (+2 MHz) interference		-42		dB
$C/I_{1M,-3MHz}$	1 Msps mode, Adjacent (-3 MHz) interference		-38		dB
$C/I_{1M,+3MHz}$	1 Msps mode, Adjacent (+3 MHz) interference		-48		dB
$C/I_{1M,\pm 6MHz}$	1 Msps mode, Adjacent ( $\geq 6$ MHz) interference		-50		dB
$C/I_{1M BLE,co-channel}$	1 Msps BLE mode, Co-Channel interference		6		dB
Symbol	Description	Min.	Typ.	Max.	Units
$C/I_{1M BLE,-1MHz}$	1 Msps BLE mode, Adjacent (-1 MHz) interference		-2		dB
$C/I_{1M BLE,+1MHz}$	1 Msps BLE mode, Adjacent (+1 MHz) interference		-9		dB
$C/I_{1M BLE,-2MHz}$	1 Msps BLE mode, Adjacent (-2 MHz) interference		-22		dB
$C/I_{1M BLE,+2MHz}$	1 Msps BLE mode, Adjacent (+2 MHz) interference		-46		dB
$C/I_{1M BLE,>3MHz}$	1 Msps BLE mode, Adjacent ( $\geq 3$ MHz) interference		-50		dB
$C/I_{1M BLE,image}$	Image frequency Interference		-22		dB
$C/I_{1M BLE,image,1MHz}$	Adjacent (1 MHz) interference to in-band image frequency		-35		dB
$C/I_{2M,co-channel}$	2 Msps mode, Co-Channel interference		10		dB
$C/I_{2M,-2MHz}$	2 Msps mode, Adjacent (-2 MHz) interference		6		dB
$C/I_{2M,+2MHz}$	2 Msps mode, Adjacent (+2 MHz) interference		-14		dB
$C/I_{2M,-4MHz}$	2 Msps mode, Adjacent (-4 MHz) interference		-20		dB
$C/I_{2M,+4MHz}$	2 Msps mode, Adjacent (+4 MHz) interference		-44		dB
$C/I_{2M,-6MHz}$	2 Msps mode, Adjacent (-6 MHz) interference		-42		dB
$C/I_{2M,+6MHz}$	2 Msps mode, Adjacent (+6 MHz) interference		-47		dB
$C/I_{2M,\geq 12MHz}$	2 Msps mode, Adjacent ( $\geq 12$ MHz) interference		-52		dB

## 5.3.7. RX Intermodulation

Symbol	Description	Min.	Typ.	Max.	Units
$P_{IMD,1M}$	IMD performance, 1 Msps, 3rd, 4th, and 5th offset channel		-33		dBm
$P_{IMD,1M,BLE}$	IMD performance, BLE 1 Msps, 3rd, 4th, and 5th offset channel		-30		dBm
$P_{IMD,2M}$	IMD performance, 2 Msps, 3rd, 4th, and 5th offset channel		-33		dBm

## 5.3.8. Radio Timing Parameters

Symbol	Description	Min.	Typ.	Max.	Units
$t_{TXEN}$	Time between TXEN task and READY event after channel FREQUENCY configured		140		us
$t_{TXEN,FAST}$	Time between TXEN task and READY event after channel FREQUENCY configured (Fast Mode)		40		us
$t_{TXDISABLE}$	Time between DISABLE task and DISABLED event when the radio was in TX and mode is set to 1Mpsps		6		us
$t_{TXDISABLE,2M}$	Time between DISABLE task and DISABLED event when the radio was in TX and mode is set to 2Mpsps		4		us
$t_{RXEN}$	Time between the RXEN task and READY event after channel FREQUENCY configured in default mode		140		us
$t_{RXEN,FAST}$	Time between the RXEN task and READY event after channel FREQUENCY configured in fast mode		40		us
$t_{SWITCH}$	The minimum time taken to switch from RX to TX or TX to RX (channel FREQUENCY unchanged)		20		us
$t_{RXDISABLE}$	Time between DISABLE task and DISABLED event when the radio was in RX		0		us
$t_{TXCHAIN}$	TX chain delay		0.6		us
$t_{RXCHAIN}$	RX chain delay		9.4		us
$t_{RXCHAIN,2M}$	RX chain delay in 2Mpsps mode		5		us

## 5.3.9. RSSI Specifications

Symbol	Description	Min.	Typ.	Max.	Units
$RSSI_{ACC}$	RSSI Accuracy Valid range -90 to -20 dBm		±2		dB
$RSSI_{RESOLUTION}$	RSSI resolution		1		dB
$RSSI_{PERIOD}$	Sample period		8		us

## 5.3.10. CPU

Symbol	Description	Min.	Typ.	Max.	Units
$W_{FLASH}$	CPU wait states, running from flash, cache disabled	0		2	
$W_{FLASHCACHE}$	CPU wait states, running from flash, cache enabled	0		3	
$W_{RAM}$	CPU wait states, running from RAM			0	
$I_{DDFLASHCACHE}$	CPU current, running from flash, cache enabled, LDO		7.4		mA
$I_{DDFLASHCACHEDCDC}$	CPU current, running from flash, cache enabled, DCDC 3V		3.7		mA
$I_{DDFLASH}$	CPU current, running from flash, cache disabled, LDO		8.0		mA
$I_{DDFLASHDCDC}$	CPU current, running from flash, cache disabled, DCDC 3V		3.9		mA
$I_{DDRAM}$	CPU current, running from RAM, LDO		6.7		mA
$I_{DDRAMDCDC}$	CPU current, running from RAM, DCDC 3V		3.3		mA
$I_{DDFLASH/MHz}$	CPU efficiency, running from flash, cache enabled, LDO		125		$\mu A /$ MHz
$I_{DDFLASHDCDC/MHz}$	CPU efficiency, running from flash, cache enabled, DCDC 3V		58		$\mu A /$ MHz

  

Symbol	Description	Min.	Typ.	Max.	Units
$CM_{FLASH}$	CoreMark <sup>3</sup> , running from flash, cache enabled		215		CoreM
$CM_{FLASH/MHz}$	CoreMark per MHz, running from flash, cache enabled		3.36		CoreM MHz
$CM_{FLASH/mA}$	CoreMark per mA, running from flash, cache enabled, DCDC 3V		58		CoreM mA

## 5.3.11. Power Management

Symbol	Description	Min.	Typ.	Max.	Units
$I_{ON\_RAMOFF\_EVENT}$	System ON, No RAM retention, Wake on any event		1.2		$\mu A$
$I_{ON\_RAMON\_EVENT}$	System ON, Full RAM retention, Wake on any event		1.5		$\mu A$
$I_{ON\_RAMOFF\_RTC}$	System ON, No RAM retention, Wake on RTC		1.9		$\mu A$
$I_{OFF\_RAMOFF\_RESET}$	System OFF, No RAM retention, Wake on reset		0.7		$\mu A$
$I_{OFF\_RAMOFF\_GPIO}$	System OFF, No RAM retention, Wake on GPIO		1.2		$\mu A$
$I_{OFF\_RAMOFF\_LPCOMP}$	System OFF, No RAM retention, Wake on LPCOMP		1.9		$\mu A$
$I_{OFF\_RAMOFF\_NFC}$	System OFF, No RAM retention, Wake on NFC field		0.7		$\mu A$
$I_{OFF\_RAMON\_RESET}$	System OFF, Full RAM retention, Wake on reset		1.0		$\mu A$

# 6. Block Diagram

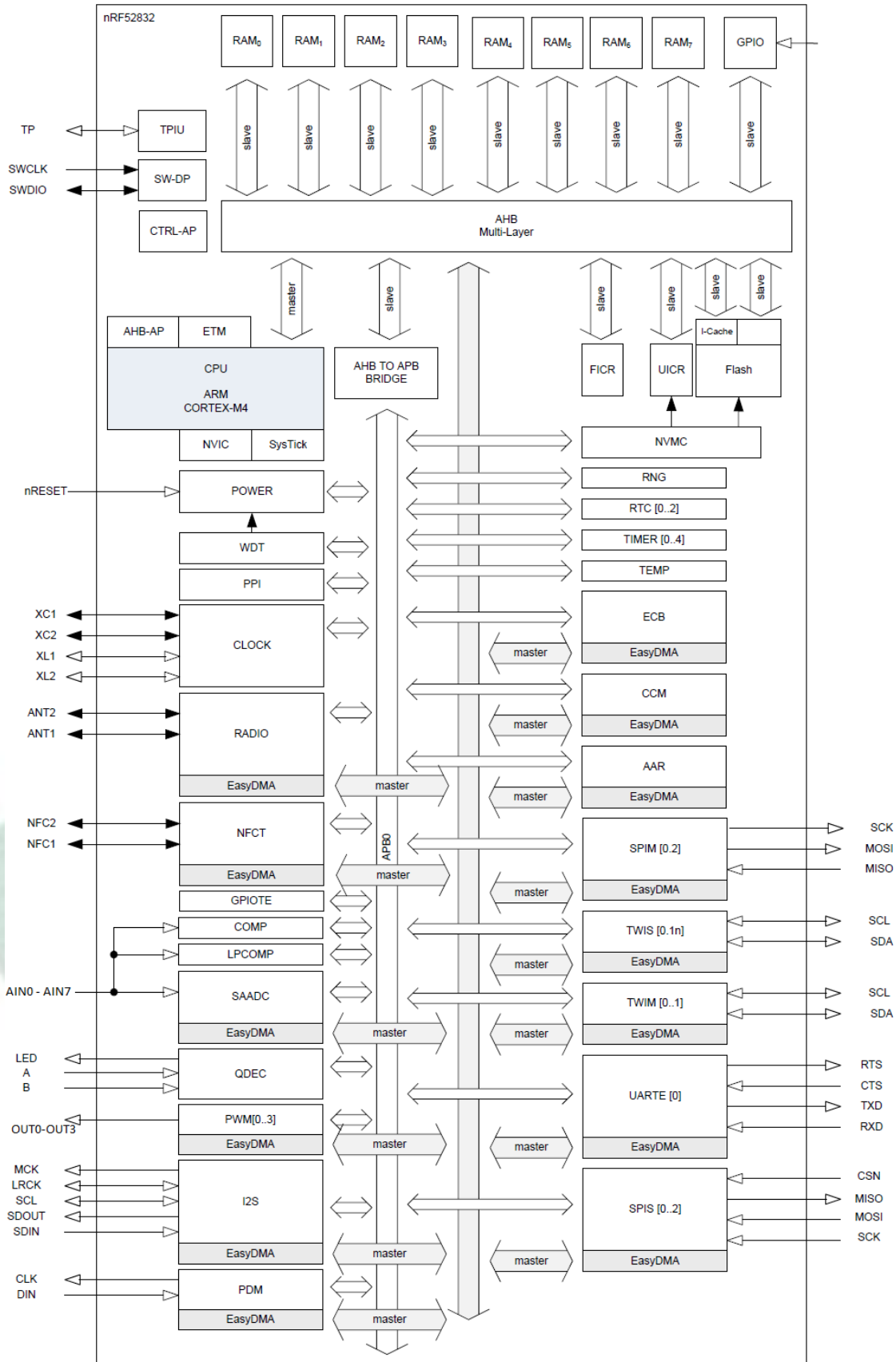

# 7. Antenna

## 7.1. MDBT42Q Series

### Test Result

Frequency (MHz)	2400	2410	2420	2430	2440	2450	2460	2470	2480	2490	2500
Gain (dBi)	-3.68	-2.91	-2.34	-1.98	-1.66	-1.60	-1.77	-2.09	-2.60	-3.35	-4.10
Peak EIRP (dBm)	-3.68	-2.91	-2.34	-1.98	-1.66	-1.60	-1.77	-2.09	-2.60	-3.35	-4.10
Directivity (dBi)	4.98	5.11	5.12	5.02	4.93	4.76	4.58	4.38	4.11	3.77	3.42

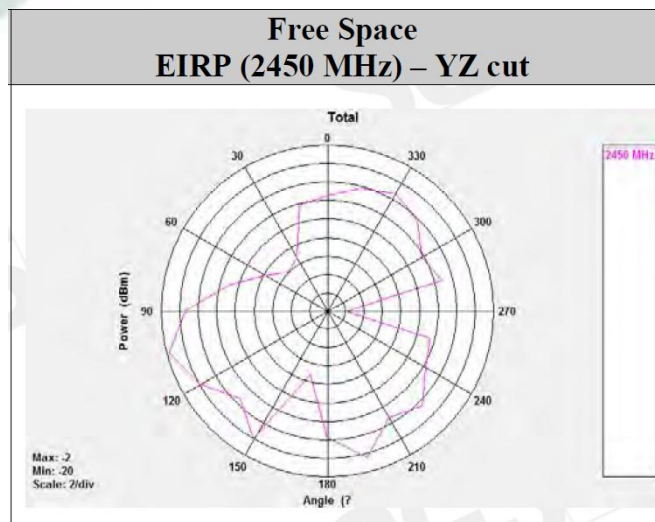
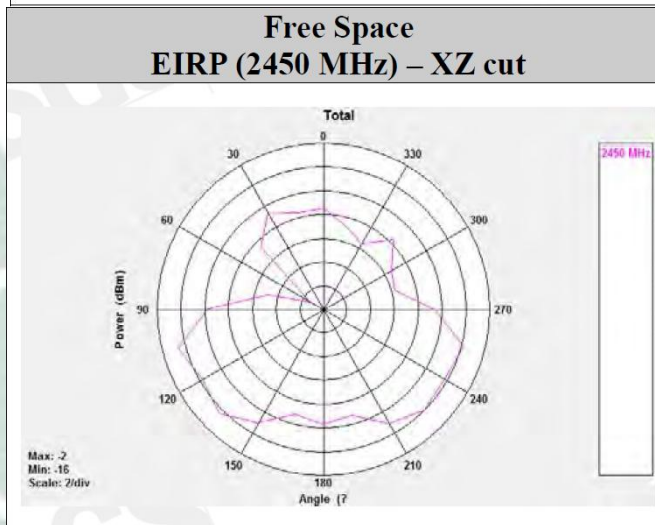
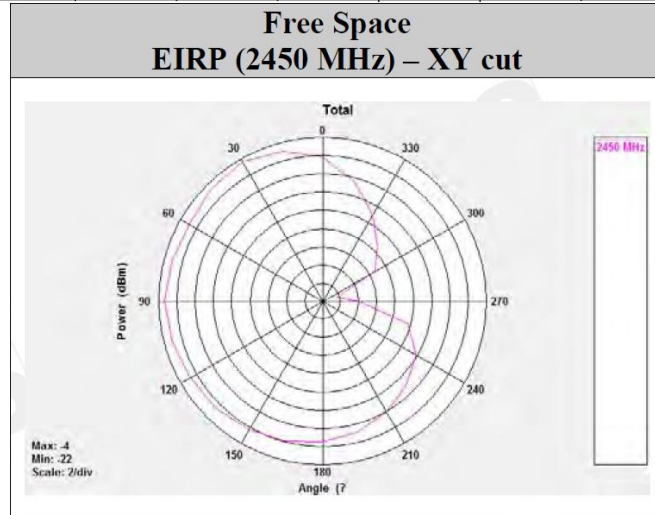

## 7.2. MDBT42Q-P Series

### Test Result

Frequency (MHz)	2400	2410	2420	2430	2440	2450	2460	2470	2480	2490	2500
Gain (dBi)	-3.87	-3.06	-2.31	-2.01	-2.04	-2.31	-2.24	-1.96	-1.61	-1.71	-1.97
Peak EIRP (dBm)	-3.87	-3.06	-2.31	-2.01	-2.04	-2.31	-2.24	-1.96	-1.61	-1.71	-1.97
Directivity (dBi)	3.79	4.00	4.25	4.17	3.86	3.51	3.54	3.91	4.39	4.44	4.49

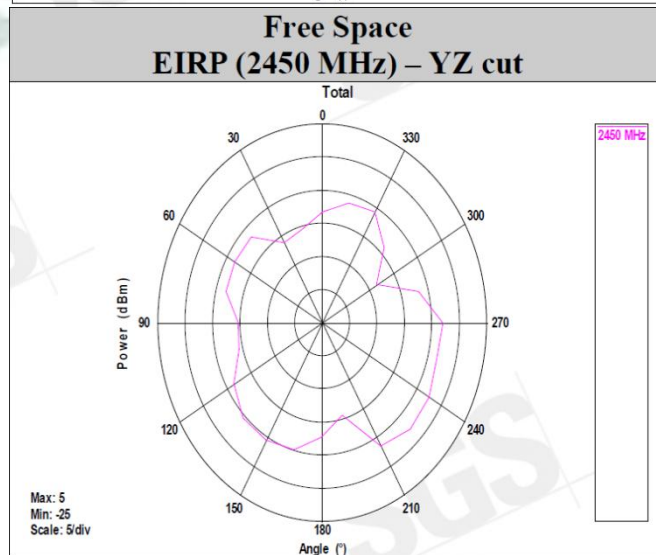
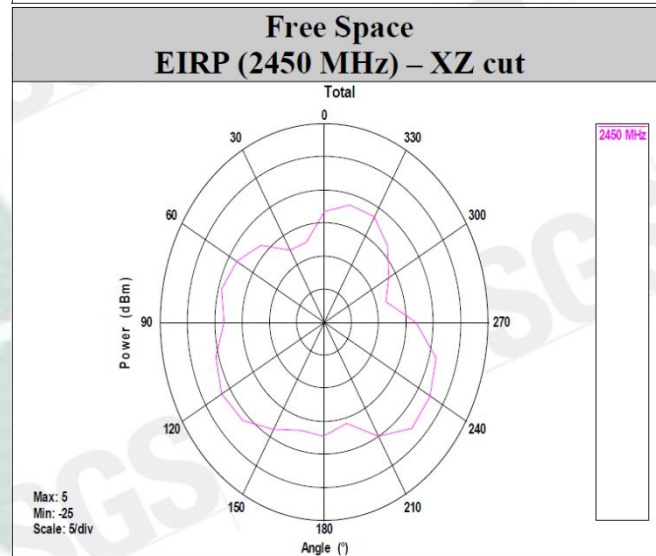
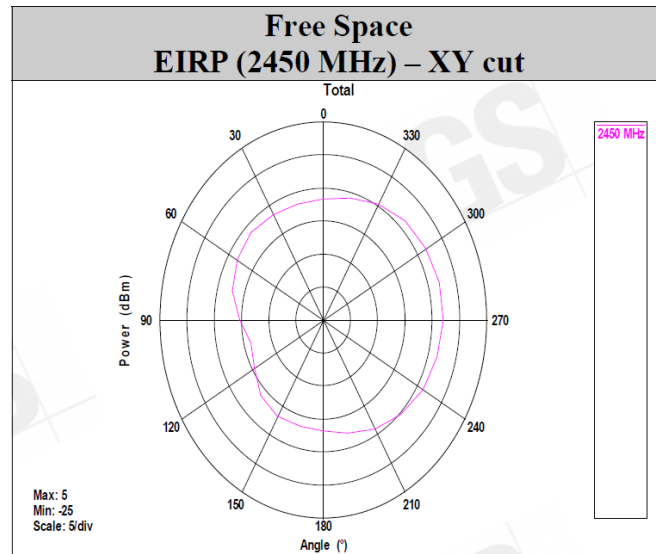



# 8. Reference Circuit

Module's default is using internal DC-DC mode.

**REMARK:**

- \*\* When not using DC-DC mode, please remove L2 / L3 / C13. \*\*
- \*\* When not using NFC, please remove NFC1 / C19 / C21. \*\*
- \*\* When using internal 32.768khz RC oscillator, please remove X2 / C12 / C13. \*\*

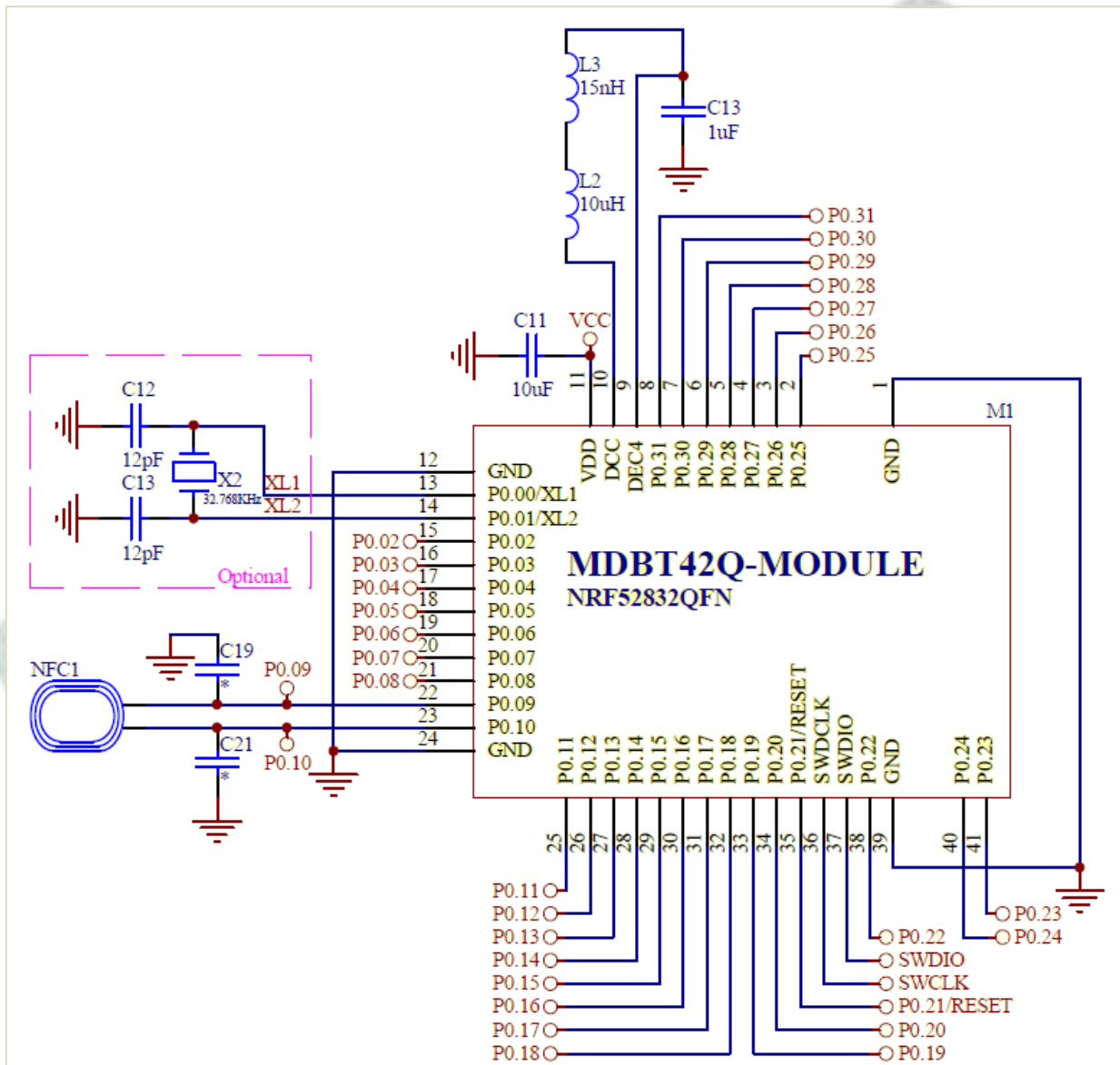



# 9. Certification

## 9.1. FCC Certificate (USA)



### TCB

**GRANT OF EQUIPMENT AUTHORIZATION**

Certification  
 Issued Under the Authority of the  
 Federal Communications Commission

By:

Telefication B.V.  
 Edisonstraat 12a  
 Zevenaar, NL-6902 PK  
 Netherlands

### TCB

**Raytac Corp.**  
 5F., No.3, Jiankang Rd., Zhonghe Dist.,  
 New Taipei City,, 23586  
 Taiwan

Attention: Venson Liao , R&D Manager

Date of Grant: 08/19/2016

Application  
 Dated: 08/15/2016

**NOT TRANSFERABLE**

EQUIPMENT AUTHORIZATION is hereby issued to the named GRANTEE, and is VALID ONLY for the equipment identified hereon for use under the Commission's Rules and Regulations listed below.

<b>FCC IDENTIFIER:</b>	SH6MDBT42Q	
<b>Name of Grantee:</b>	Raytac Corp.	
<b>Equipment Class:</b>	Digital Transmission System	
<b>Notes:</b>	BT 4.2 Module	
<b>Modular Type:</b>	Single Modular	

Grant Notes	FCC Rule Parts	Frequency Range (MHZ)	Output Watts	Frequency Emission Tolerance Designator
	15C	2402.0 - 2480.0	0.0023	

Power output listed is conducted. This grant is valid only when the module is sold to OEM integrators and must be installed by the OEM or OEM integrators. The antenna's as listed in this application must be installed to provide a separation distance of at least 20 cm from all persons and must not be co-located or operating in conjunction with any other antenna or transmitter. End-users may not be provided with the module installation instructions. OEM integrators and end-users must be provided with transmitter operating conditions for satisfying RF exposure compliance.

Certificate No.: 162181172/AA/00	Ramy Nabod Product Assessor	
-------------------------------------	--------------------------------	---

## 9.2. TELEC Certificate (Japan)

telefication bv  
The Netherlands  
Chamber of Commerce  
51565536  
www.telefication.com



**Certificate**  
of  
Radio Equipment in JAPAN

No: 201-160496 / 00

Telefication, operating as Conformity Assessment Body (CAB ID Number: 201) with respect to Japan, declares that the listed product complies with the Technical Regulations Conformity Certification of Terminal equipment (ordinance of MPT N° 31,1984)

Product description: **BT 4.2 Module**  
Trademark: **Raytac**  
Type designation: **MDBT42Q**  
Hardware / Software version: 1 / 1  
Variants: **See Annex 3**

Manufacturer: **Raytac Corporation**  
Address: **5F, No.3, Jiankang Rd., Zhonghe Dist.,  
City: New Taipei 23586**  
Country: **Taiwan**

This statement is granted to:

Name: **Raytac Corporation**  
Address: **5F, No.3, Jiankang Rd., Zhonghe Dist.,  
City: New Taipei 23586**  
Country: **Taiwan**

This statement has **THREE** Annexes.

Zevenaar, 19 August 2016

**CAB**



Ramy Nabod  
Product Assessor



**PRODUCTS**  
**RvA C 224**

## 9.3. NCC Certificate (Taiwan)

### MDBT42Q Series

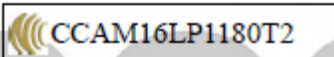
	<b>台灣檢驗科技股份有限公司</b>
<b>低功率射頻電機型式認證證明</b>	
一、申請者：	勁達國際電子有限公司
地 址：	新北市中和區建康路3號5樓
二、製造廠商：	Ginstar Corporation
三、器材名稱：	BT 4.2 Module
四、廠 牌：	Raytac
五、型 號：	MDBT42Q
六、發射功率：	BT V4.2 single mode LE (GFSK): 3.57dBm (Peak)
七、工作頻率：	2402-2480MHz
八、審驗日期：	105年08月19日
九、審驗合格標籤式樣：	
說明：	
1. 請依上列標籤式樣自製標籤，標貼或印鑄於器材本體明顯處，始得販賣或公開陳列。	
2. 經型式認證合格之低功率射頻電機，其廠牌、型號、設計、射頻性能如有變更，應重新申請型式認證。	
3. 違反低功率電波輻射性電機管理辦法之規定，擅自使用或變更無線電頻率、電功率者，除依電信法規定處罰外，驗證機關(構)並得廢止其型式認證證明或型式認證標籤。	
4. 送審廠商應保留送審樣品供日後核對。	
5. 本型式認證證明及其合格標籤使用權專屬取得本證明者。依電信管制射頻器材審驗辦法第15條規定，持有人得經由網際網路申請同意他人於同廠牌同型號之電信管制射頻器材使用型式認證標籤，並於次日起30天內，應檢具「電信管制射頻器材審驗合格標籤，或符合性聲明標籤同意使用備查表」送國家通訊傳播委員會備查。	
備註：	
1. 本器材符合低功率射頻電機技術規範(3.10.1)之規定。	
2. 本公司僅對無線射頻特性技術規範辦理型式認證，其他仍須依本國相關法規辦理。	
3. 本器材使用天線型態: Chip Antenna, 天線廠牌: Raytac, 型號: MDBT42Q, 增益: -1.6dBi。	
4. 本案審驗模組為完全模組，適用於任何平台。【平台】定義如下: 若器材部組裝本案審驗模組，消費者仍能正常使用該器材主要功能，該器材得視為平台。若器材不組裝本案審驗模組，消費者不能正常使用該器材主要功能，該器材不能視為平台，該類不同廠牌型號器材組裝本案審驗模組後，須分別申請型式認證。	
5. 本公司係經國家通訊傳播委員會委託之驗證機構，核發本型式認證證明。	



## MDBT42Q-P Series

**SGS**

台灣檢驗科技股份有限公司

### 低功率射頻電機型式認證證明

- 一、申請者：勁達國際電子有限公司  
地址：新北市中和區建康路3號5樓
- 二、製造廠商：Ginstar Corporation
- 三、器材名稱：BT 4.2 Module
- 四、廠牌：Raytac
- 五、型號：MDBT42Q-P
- 六、發射功率：BT V4.2 single mode LE (GFSK): 3.57dBm (Peak)
- 七、工作頻率：2402-2480MHz
- 八、審驗日期：105年08月19日
- 九、審驗合格標籤式樣：



#### 說明：

- 請依上列標籤式樣自製標籤，標貼或印鑄於器材本體明顯處，始得販賣或公開陳列。
- 經型式認證合格之低功率射頻電機，其廠牌、型號、設計、射頻性能如有變更，應重新申請型式認證。
- 違反低功率電波輻射性電機管理辦法之規定，擅自使用或變更無線電頻率、電功率者，除依電信法規定處罰外，驗證機關(構)並得廢止其型式認證證明或型式認證標籤。
- 送審廠商應保留送審樣品供日後核對。
- 本型式認證證明及其合格標籤使用權專屬取得本證明者。依電信管制射頻器材審驗辦法第15條規定，持有人得經由網際網路申請同意他人於同廠牌同型號之電信管制射頻器材使用型式認證標籤，並於次日起30天內，應檢具「電信管制射頻器材審驗合格標籤，或符合性聲明標籤同意使用備查表」送國家通訊傳播委員會備查。

#### 備註：

- 本器材符合低功率射頻電機技術規範(3.10.1)之規定。
- 本公司僅對無線射頻特性技術規範辦理型式認證，其他仍須依本國相關法規辦理。
- 本器材使用天線型態: PCB Antenna，天線廠牌: Raytac，型號: MDBT42Q-P，增益: -1.61dBi。
- 本案審驗模組為完全模組，適用於任何平台。【平台】定義如下:若器材部組裝本案審驗模組，消費者仍能正常使用該器材主要功能，該器材得視為平台。若器材不組裝本案審驗模組，消費者不能正常使用該器材主要功能，該器材不能視為平台，該類不同廠牌型號器材組裝本案審驗模組後，須分別申請型式認證。
- 本公司係經國家通訊傳播委員會委託之驗證機構，核發本型式認證證明。



## 9.4. IC Certificate (Canada)

<p>telefication bv The Netherlands Chamber of Commerce 51565536 www.telefication.com</p>			
<p><b>TECHNICAL ACCEPTANCE CERTIFICATE</b></p>		<p><b>CERTIFICAT D'ACCEPTABILITÉ TECHNIQUE</b></p>	
CERTIFICATION No. No. DE CERTIFICATION	8017A-MDBT42Q		
TELEFICATION No. No. DE TELEFICATION	162170280/AA/00		
TEST SITE No. No. DE LABORATOIRE	4620A-5		
ISSUED TO DÉLIVRÉ A	Raytac Corporation		
TYPE OF EQUIPMENT GENRE DE MATÉRIEL	Bluetooth device		
TRADE NAME AND MODEL MARQUE ET MODELE	Raytac / MDBT42Q Raytac / MDBT42Q-P		
CERTIFIED TO CERTIFIÉ SELON LE	SPECIFICATION CAHIER DES CHARGES	RSS-102 RSS-247	ISSUE EDITION
			5 1
<p>Certification of equipment means only that the equipment has met the requirements of the above-noted specification. Licence applications, where applicable to use certified equipment, are acted on accordingly by the Industry Canada issuing office and will depend on the existing radio environment, service and location of operation. This certificate is issued on condition that the holder complies and will continue to comply with the requirements and procedures issued by Industry Canada. The equipment for which this certificate is issued shall not be manufactured, imported, distributed, leased, offered for sale or sold unless the equipment complies with the applicable technical specifications and procedures issued by Industry Canada.</p>		<p>La certification du matériel signifie seulement que le matériel a satisfait aux exigences de la norme indiquée ci-dessus. Les demandes de licences nécessaires pour l'utilisation du matériel certifié sont traitées en conséquence par le bureau de délivrance d'Industrie Canada et dépendent des conditions radio ambiantes, du service et de l'emplacement d'exploitation. Le présent certificat est délivré à la condition que le titulaire satisfasse et continue de satisfaire aux exigences et aux procédures d'Industrie Canada. Le matériel à l'égard duquel le présent certificat est délivré ne doit pas être fabriqué, importé, distribué, loué, mis en vente ou vendu à moins d'être conforme aux procédures et aux spécifications techniques applicables publiées par Industrie Canada.</p>	
<p>ISSUED BY TELEFICATION BV, RECOGNIZED CERTIFICATION BODY BY INDUSTRY CANADA DÉLIVRÉ PAR TELEFICATION BV, ORGANISME DE CERTIFICATION RECONNU PAR INDUSTRIE CANADA</p>			
<p><i>I hereby attest that the subject equipment was tested and found in compliance with the above-noted specification. J'atteste, par la présente, que le matériel a fait l'objet d'essai et a été jugé conforme à la spécification ci-dessus</i></p>			
DATE 19 Aug 2016 BY	Ramy Nabod Product Assessor		
This certificate has one annex.			
			
			

## 9.5. SRRC Certificate (China)

**无线电发射设备**  
Radio Transmission Equipment  
**型号核准证**  
Type Approval Certificate

劲达国际电子有限公司（台湾）：

**根据《中华人民共和国无线电管理条例》，经审查，下列无线电发射设备**  
In accordance with the provisions on the Radio  
Regulations of the People's Republic of China , the following  
**符合中华人民共和国无线电管理规定和**  
radio transmission equipment , after examination , conforms  
**技术标准，其核准代码为：CMIIT ID: 2016DJ4571**  
to the provisions with its CMIIT ID:

  
Sealed by Issuing Authority

有效期：五年  
Validity

2016 年 8 月 12 日  
Year Month Date

## 9.6. RoHS & REACH Report

Please click link below to download full report.

- [RoHS Report for MDBT42Q](#)
- [RoHS Report for MDBT42Q-P](#)
- [REACH Report for MDBT42Q](#)
- [REACH Report for MDBT42Q-P](#)



## 9.7. End-Product Label

It is suggested using following content adding to package or user manual or label to obey the regulation. Any rules of end-product label shall refer to each certification for final reference.

### 9.7.1. FCC (USA)

The FCC statement should be included in the user manual when there is no enough space on label. Otherwise, it should be included on the label.

“This device complies with part 15 of the FCC rules. Operation is subject to the following two conditions. (1) This device may not cause harmful interference. (2) This device must accept any interference received, including interference that may cause undesired operation.”

The final end product must be labeled in a visible area with the following: “Contain FCC ID: SH6MDBT42Q”.

### 9.7.2. TELEC (Japan)

When manufacturer is placing the product on the Japanese market, the product must be affixed with the following Specified Radio Equipment marking:

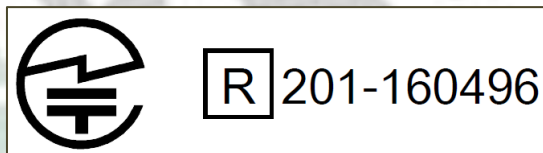



### 9.7.3. NCC (Taiwan)

請依下列標籤式樣自製標籤，標貼或印鑄於器材本體明顯處，始得販賣或公開陳列。

**MDBT42Q Series**

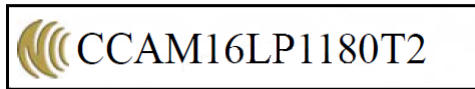

**MDBT42Q-P Series**

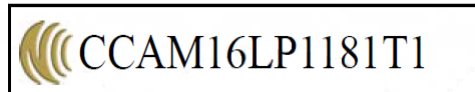

平台廠商必須於平台上標示字樣「本產品內含射頻模組：ID 編號 CCAM16LP1180T2」或「本產品內含射頻模組：ID 編號 CCAM16LP1181T1」。

「平台」定義如下：若器材組裝本案模組，消費者仍能正常使用該器材主要功能，該器材得視為平台。若器材不組裝本案模組，消費者不能正常使用該器材主要功能，該器材不能視為平台。該類不同廠牌型號器材組裝本案審驗模組後，須分別申請型式認證。

### 9.7.4. IC (Canada)

The IC statement should be included in the user manual when there is no enough space on label. Otherwise, it should be included on the label.

“This device complies with Industry Canada license-exempt RSS Standard(s). Operation is subject to the following two conditions. (1) This device may not cause harmful interference. (2) This device must accept any interference received, including interference that may cause undesired operation.

Le présent appareil est conforme aux CNR d'Industrie Canada applicables aux appareils radio exempts de licence. L'exploitation est autorisée aux deux conditions suivantes: (1) l'appareil ne doit pas produire de brouillage, et (2) l'utilisateur de l'appareil doit accepter tout brouillage radioélectrique subi, même si le brouillage est susceptible d'en compromettre le fonctionnement.”

The final end product must be labeled in a visible area with the following: “Contain IC ID: 8017A-MDBT42Q”.

# Release Note

- 2016/03/24 Version A: 1<sup>st</sup> release
- 2016/08/26 Version B:
  - (1) Updated list of Raytac's BLE model no..
  - (2) Added schematic of MDBT42Q-P and RF layout reference in Chapter 2.
  - (3) Updated packing info in Chapter 4.
  - (4) Added antenna info in Chapter 7.
  - (5) Updated info of regional certificates in Chapter 9.

