

Note: VDD_PADS powers the internal PIO of the module

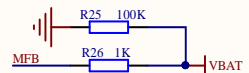

Power on boot

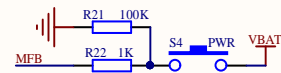

Button boot

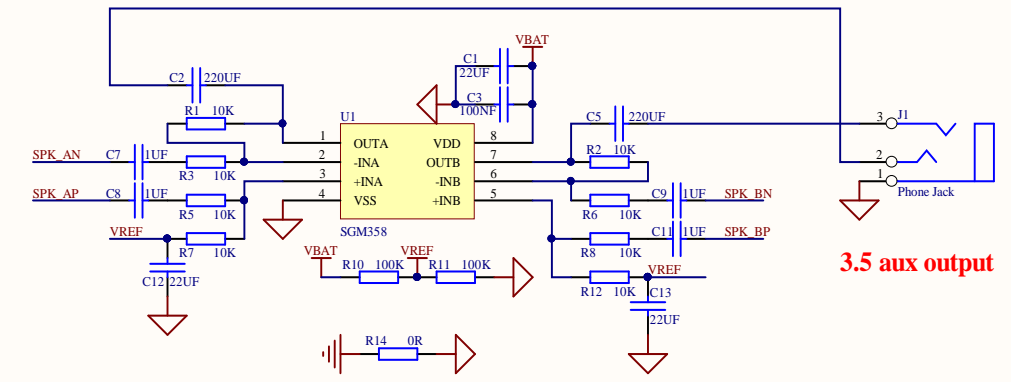

Differential to single-ended analog audio output

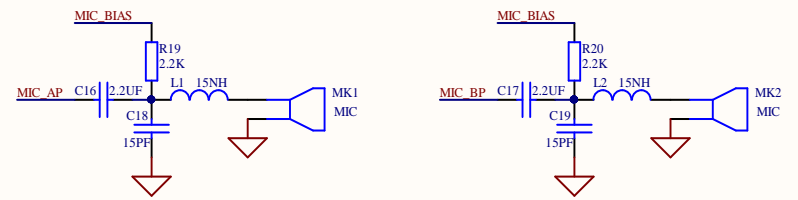

microphone input

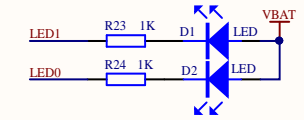

LED : led0 red led1 blue

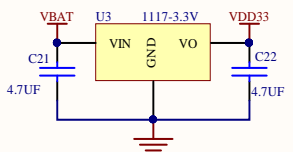

VBAT voltage 3.3-4.2V

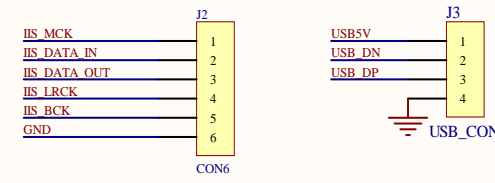

I2S Digital audio output

Title		
Size	Number	Revision
A4		
Date:	2021-11-21	Sheet of
File:	E:\Bluetooth\TS3031.Sch	Drawn By: